

Optie RO02 - aanbouw 2400mm - bnr: 16, 17 en 18

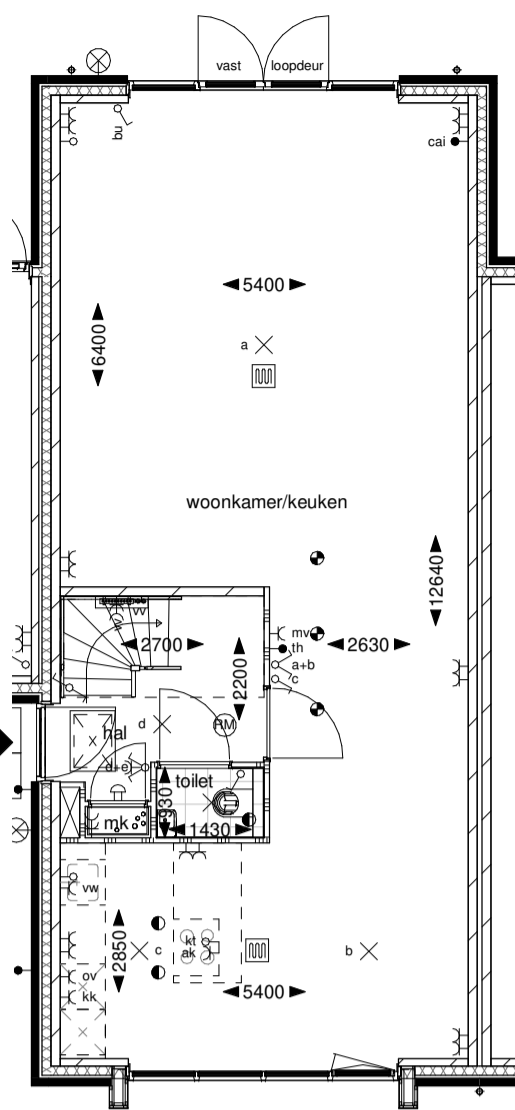

Begane grond

Blok 5 - bnr: 16 t/m17

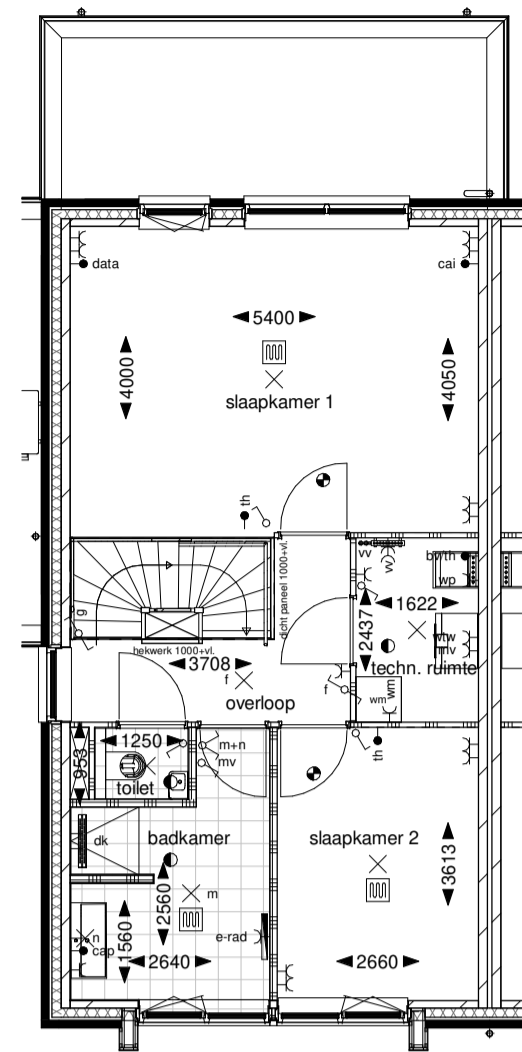

Eerste verdieping

Blok 6 - bnr: 18

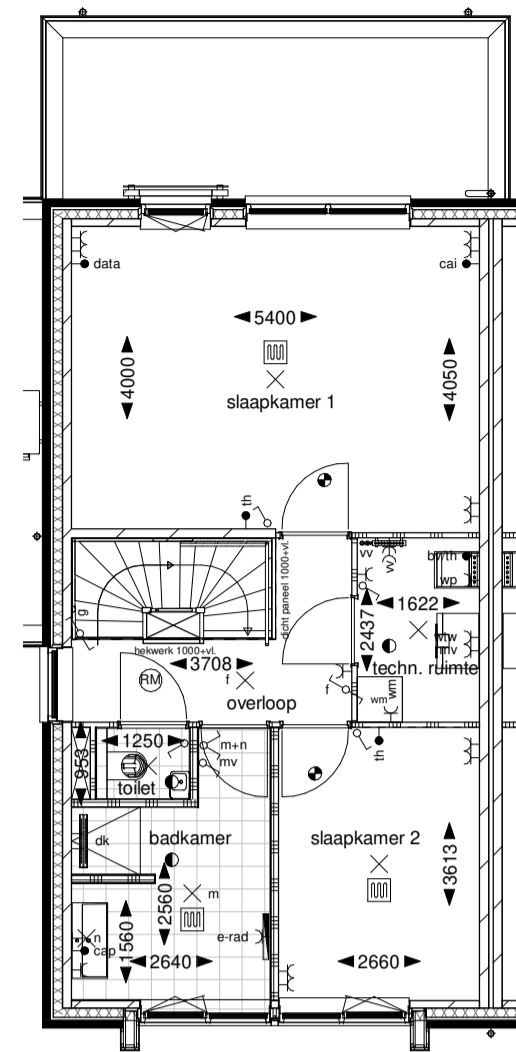

Eerste verdieping

Blok 5 - bnr: 16 t/m17



Achtergevel

Blok 6 - bnr: 18



Achtergevel

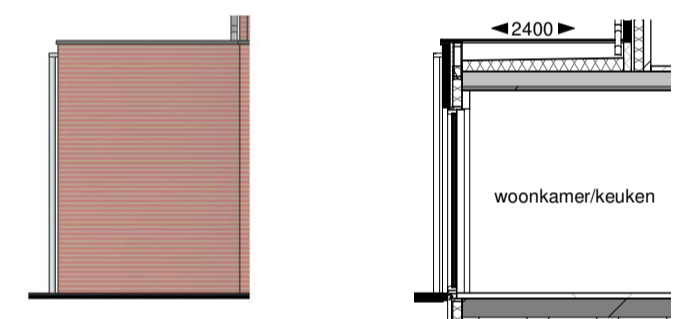

Linker zijgevel Doorsnede

Optie RO03 - deur berging - woning - bnr: 16, 17 en 18

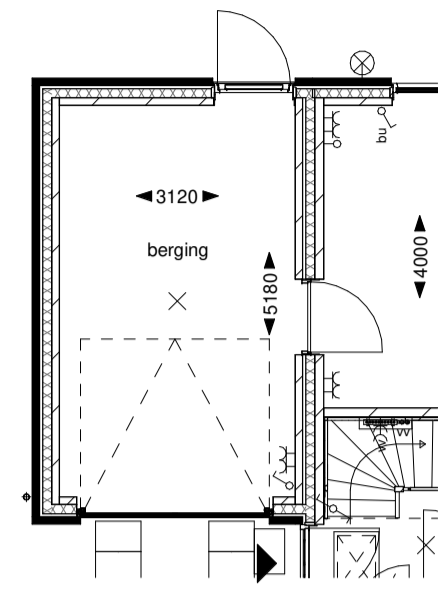

Begane grond

Optie RO04 - berging bij woning - bnr: 16, 17 en 18

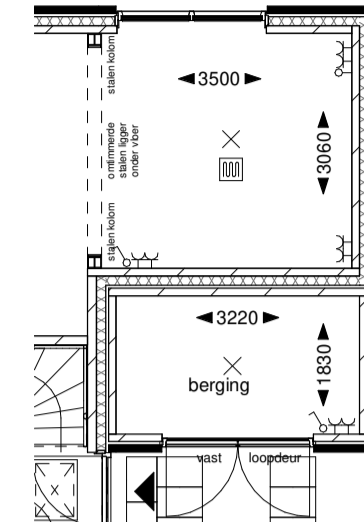

Begane grond

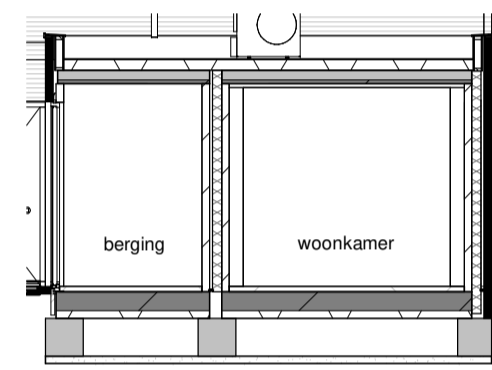

Doorsnede

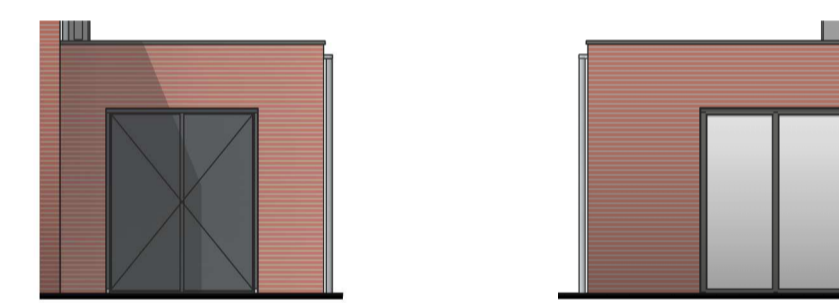

Voorgevel

Achtergevel

Optie RO05 - uitbouw met berging bij woning - bnr: 16, 17 en 18

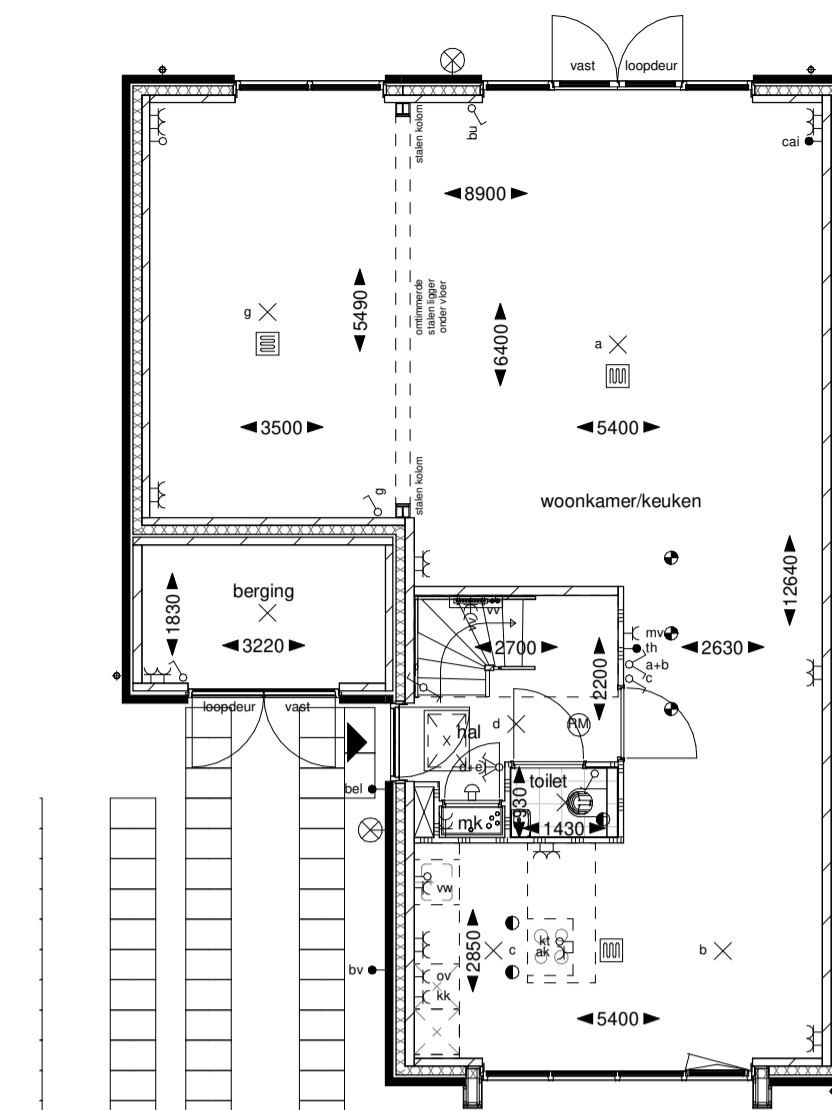

Begane grond

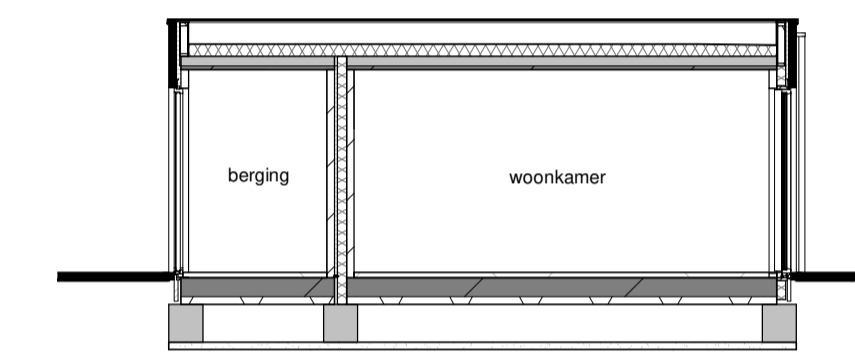

Doorsnede

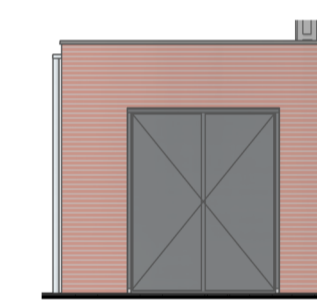

Voorgevel

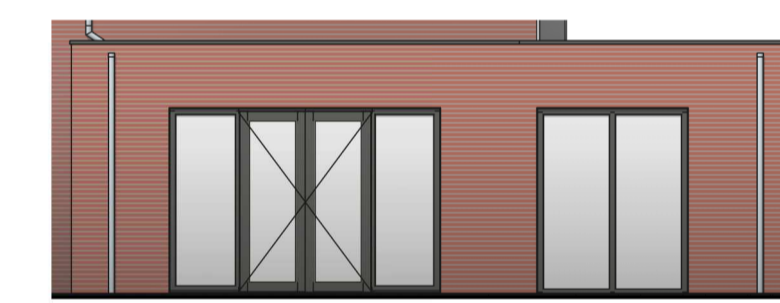

Achtergevel

Optie RO08 - dakramen - bnr: 16 t/m19

Blok 5 - bnr: 16 t/m17

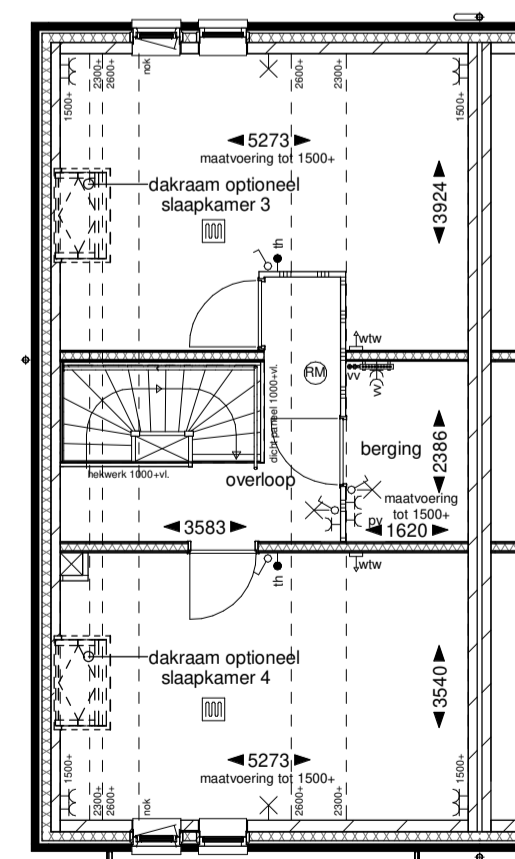

Tweede verdieping

Blok 6 - bnr: 18 t/m19

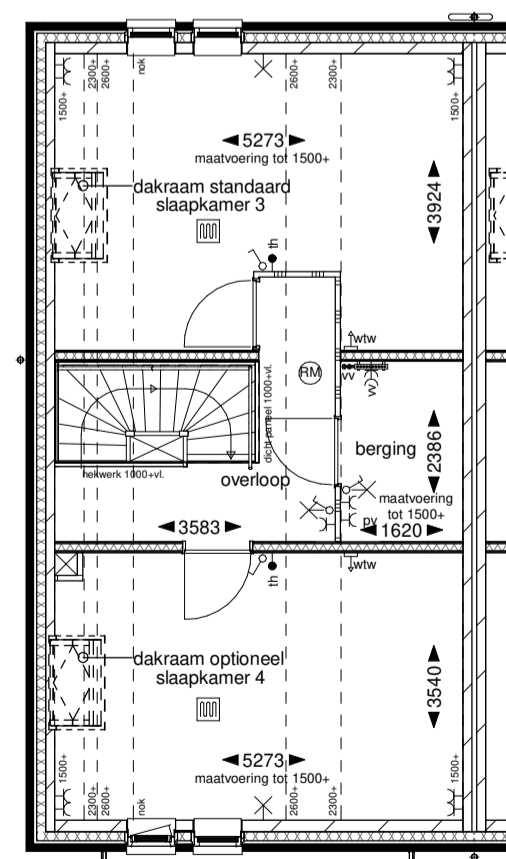

Tweede verdieping

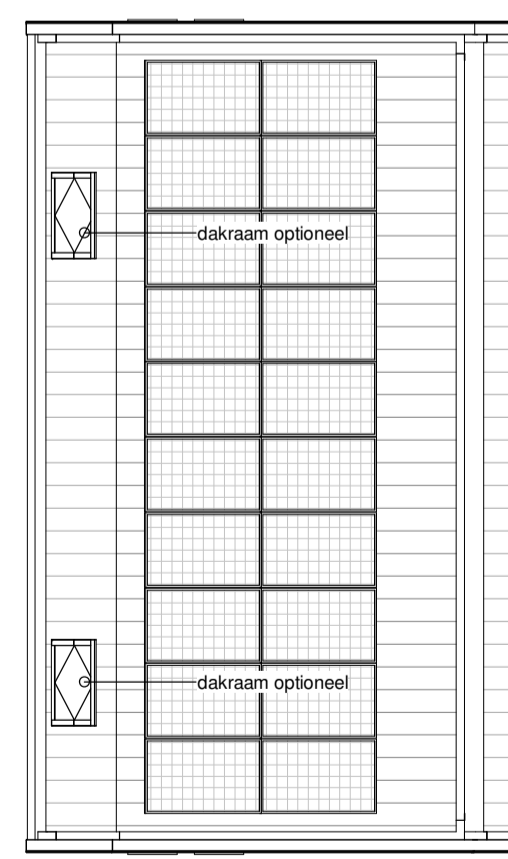

Dakaanzicht

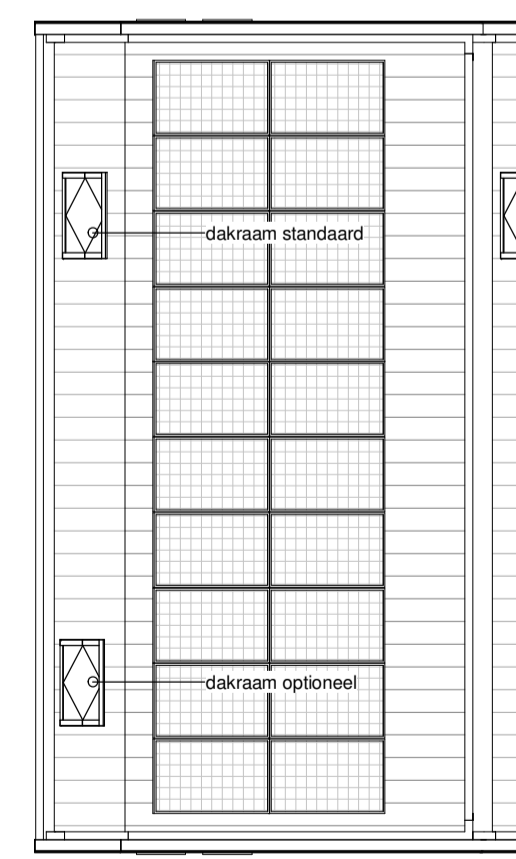

Dakaanzicht

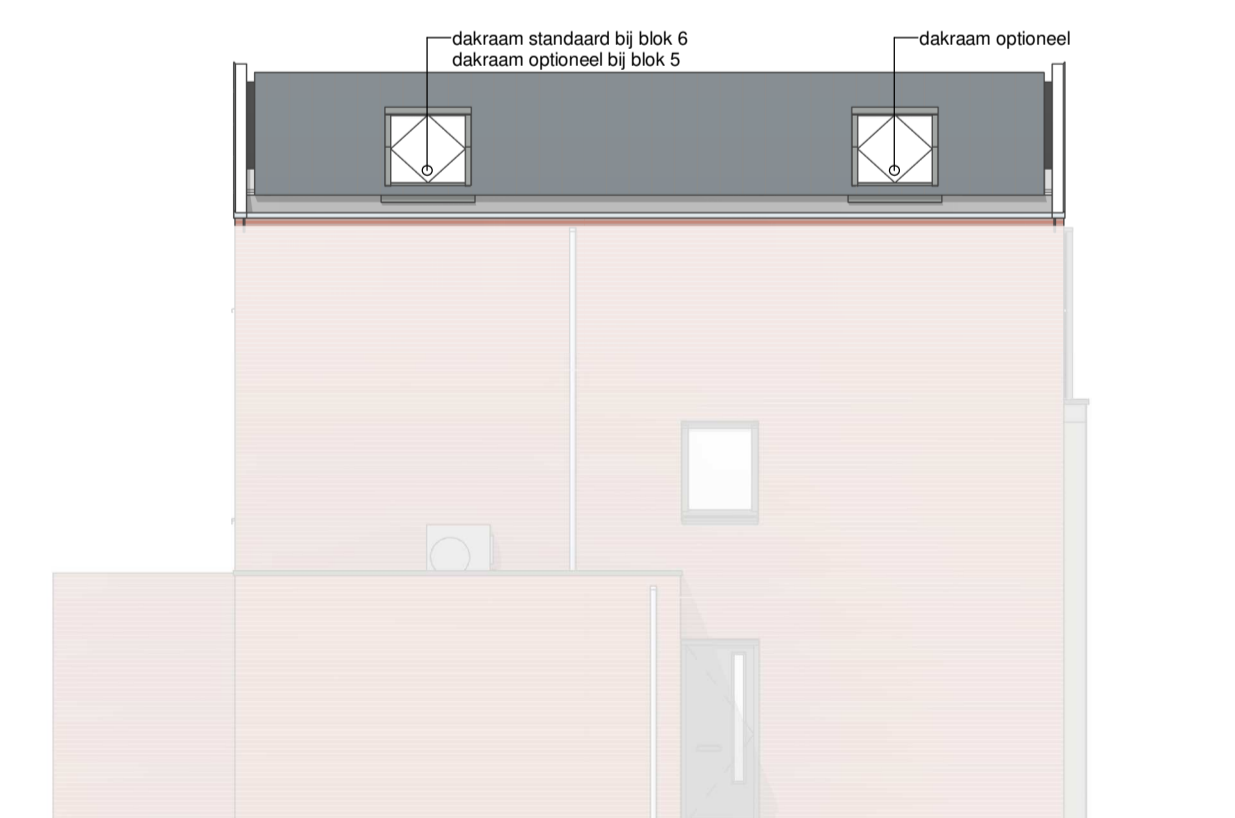

Linker zijgevel

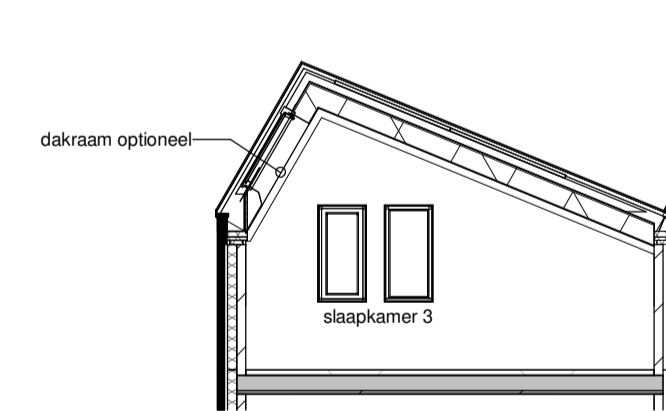

Doorsnede

Optie RO09 - dubbele deur berging - bnr: 16, 17 en 18

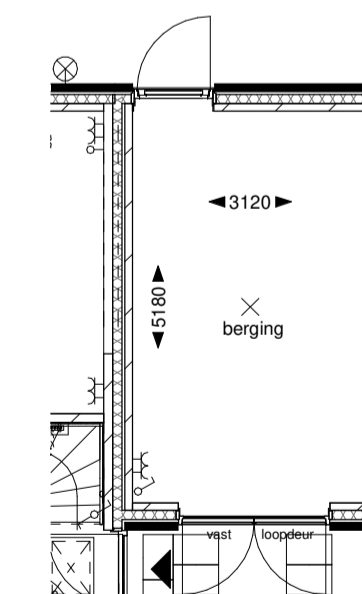

Begane grond

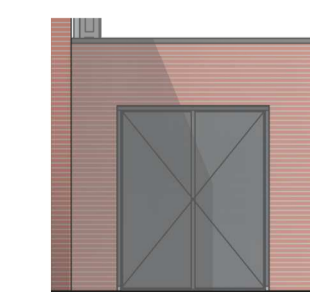

Voorgevel